

# Type H3 Load Cell



## Short description



- Nickel plated alloy steel IP67 "S" type load cell
- Tension and compression applications
- Suitable for hanging, hopper and other weighing devices
- Also available in imperial capacities and dimensions

 OIML test certificate no. D09-03.18 Revision 2  
C of C no R60/2000-CNI-00.01

 Certificate no. 06-099A1

## Available models

Capacity	Accuracy	Full article description
25kg	C3 Excluded from OIML	H3-C3-25kg-3B
50kg	C3 Excluded from OIML	H3-C3-50kg-3B
100kg	C3/C4	H3-C3/C4-100kg-3B
150kg	C3/C4	H3-C3/C4-150kg-3B
200kg	C3/C4	H3-C3/C4-200kg-3B
250kg	C3/C4	H3-C3/C4-250kg-3B
300kg	C3/C4	H3-C3/C4-300kg-3B
500kg	C3/C4	H3-C3/C4-500kg-3B
600kg	C3/C4	H3-C3/C4-600kg-3B
750kg	C3/C4	H3-C3/C4-750kg-3B
1t	C3/C4	H3-C3/C4-1t-3B
1.5t	C3/C4	H3-C3/C4-1.5t-3B
2t	C3/C4	H3-C3/C4-2t-6B
2.5t	C3/C4	H3-C3/C4-2.5t-6B
3t	C3 Excluded from OIML	H3-C3-3t-6B
5t	C3 Excluded from OIML	H3-C3-5t-6B
7.5t	C3 Excluded from OIML	H3-C3-7.5t-6B
10t	C3 Excluded from OIML	H3-C3-10t-6B
15t	C3 Excluded from OIML	H3-C3-15t-6B
20t	C3 Excluded from OIML	H3-C3-20t-6B
30t	C3 Excluded from OIML	H3-C3-30t-6B

Specifications and dimensions are subject to change without notice and do not constitute any liability whatsoever.

# Type H3 Load Cell

## Detailed specifications H3

Accuracy class		OIML R60 C3	OIML R60 C4	C3
Output sensitivity ( = FS )	mV/V	2.0 ± 0.004		
Maximum capacity ( E <sub>max</sub> )	t	0.1, 0.15, 0.2, 0.25, 0.3, 0.5, 0.6, 0.75, 1, 1.5, 2, 2.5		0.025, 0.05, 3.0, 5.0, 7.5, 10, 15, 20, 30
Max.number of load cell intervals	n <sub>LC</sub>	3000	4000	3000
Ratio of min. LC verification interval	$Y = E_{max} / v_{min}$	10000	20000	10000
Combined Error	%FS	≤± 0.020	≤± 0.018	≤± 0.020
Minimum dead load	Of E <sub>max</sub>	0%		
Safe overload	of E <sub>max</sub>	150 %		
Ultimate overload	of E <sub>max</sub>	300 %		
Zero balance	of FS	< ± 1.5 %		
Excitation, recommended voltage	V	5 ~ 12		
Excitation maximum	V	18		
Input resistance	Ω	350 ± 3.5		
Output resistance	Ω	351 ± 2.0		
Insulation resistance	MΩ	≥5000 ( at 50VDC )		
Compensated temperature	°C	-10 ~ +40		
Operating temperature	°C	-35 ~ +65		
Storage temperature	°C	-40 ~ +70		
Element material		Nickel plated alloy steel		
Ingress Protection (acc. to EN 60529)		IP67		
Recommended torque on fixation	Nm	M8:25 M10: 50 M12:75 M20:450 M33:750	M42:1450	
ATEX classification (optional)		II1G Ex ia II1C T4	II1D Ex iaD 20 T73°C	II3G nL IIC T4

## Wiring

### Wiring:

Shielded, 4 conductor cable.

Cable diameter: Ø5mm

Standard cable length for 25kg – 1.5t: 3m and for 2t – 30t: 6m.

Shield not connected to element.

### 4-wire diagram

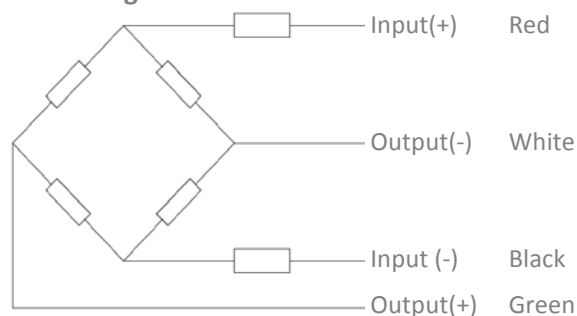

Specifications and dimensions are subject to change without notice and do not constitute any liability whatsoever.

Dimensions in mm

## 25kg–5t 0.1–20Klb

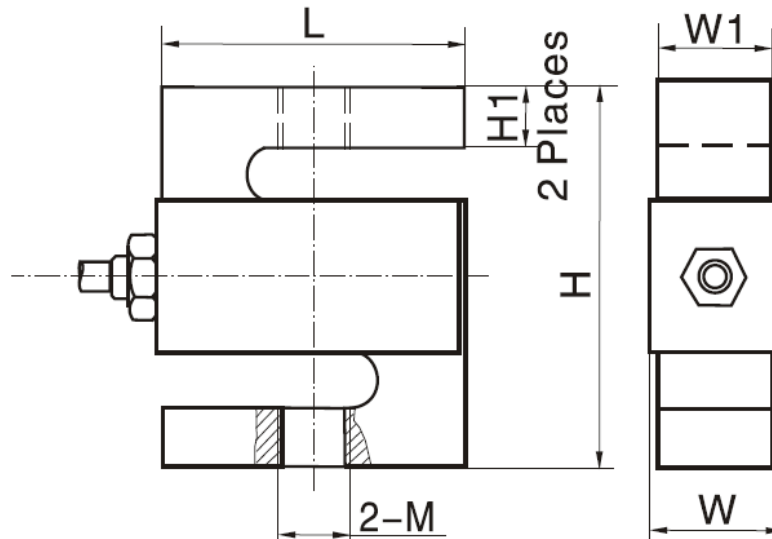

## 7.5t–30t

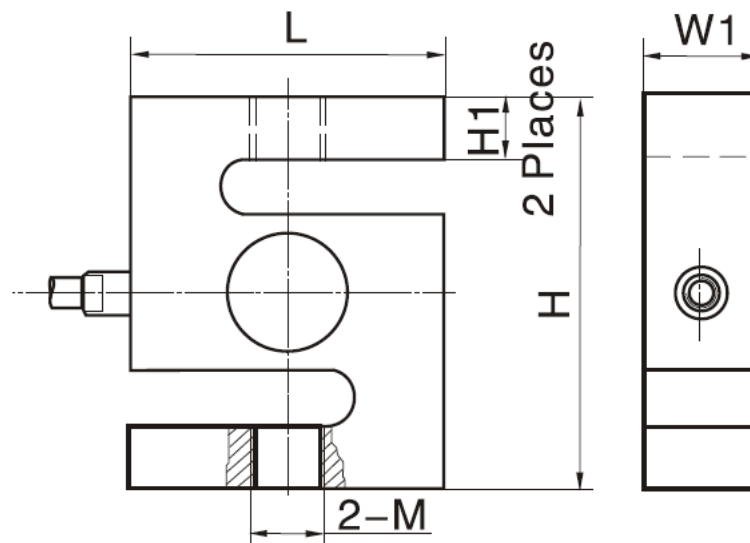

Dimension Capacity	L	H	W1	W	H1	M
25-50kg	50.8	76.2	12.7	14.5	15.7	M8
100-150kg	50.8	76.2	19.0	20.8	15.3	M10 x 1.5
200-750kg	50.8	76.2	19.0	20.8	13.6	M12 x 1.75
1-1.5t	50.8	76.2	25.4	27.2	12.1	M12 x 1.75
2-5t	76.2	101.6	25.4	27.2	20	M20 x 1.5
7.5-10t	125	175	50	-	40.2	M33 x 3
15-20t	160	200	60	-	51	M42x 3
30t	190	230	80	-	57.5	M42 x 3

Specifications and dimensions are subject to change without notice and do not constitute any liability whatsoever.

# Type H3 Load Cell

## Available accessories

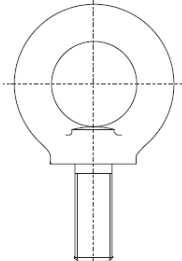
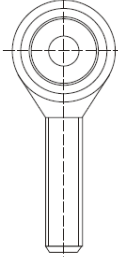
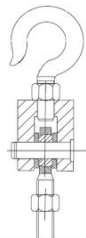
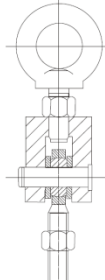
<p><b>HL-3-001-25kg-5t hook</b></p> <ul style="list-style-type: none"><li>• Alloy Steel</li><li>• Suitable for hybrid scales, crane scales, packaging scales and hopper scales</li></ul>	
<p><b>HL-3-002-25kg-5t eye</b></p> <ul style="list-style-type: none"><li>• Alloy Steel</li><li>• Suitable for hybrid scales, crane scales, packaging scales and hopper scales</li></ul>	
<p><b>HL-3-003-25kg-5t rod end</b></p> <ul style="list-style-type: none"><li>• Alloy Steel</li><li>• Suitable for hybrid scales, crane scales, packaging scales, hopper scales and other electronic weighing devices.</li></ul>	
<p><b>HL-3-004-25kg-5t hook assembly</b></p> <ul style="list-style-type: none"><li>• Alloy Steel</li><li>• Suitable for hybrid scales, crane scales, packaging scales, hopper scales and other electronic weighing devices.</li></ul>	
<p><b>HL-3-005-25kg-5t eye assembly</b></p> <ul style="list-style-type: none"><li>• Alloy Steel</li><li>• Suitable for hybrid scales, crane scales, packaging scales, hopper scales and other electronic weighing devices.</li></ul>	

Specifications and dimensions are subject to change without notice and do not constitute any liability whatsoever.